

Standard equipment to Vaculyft machines

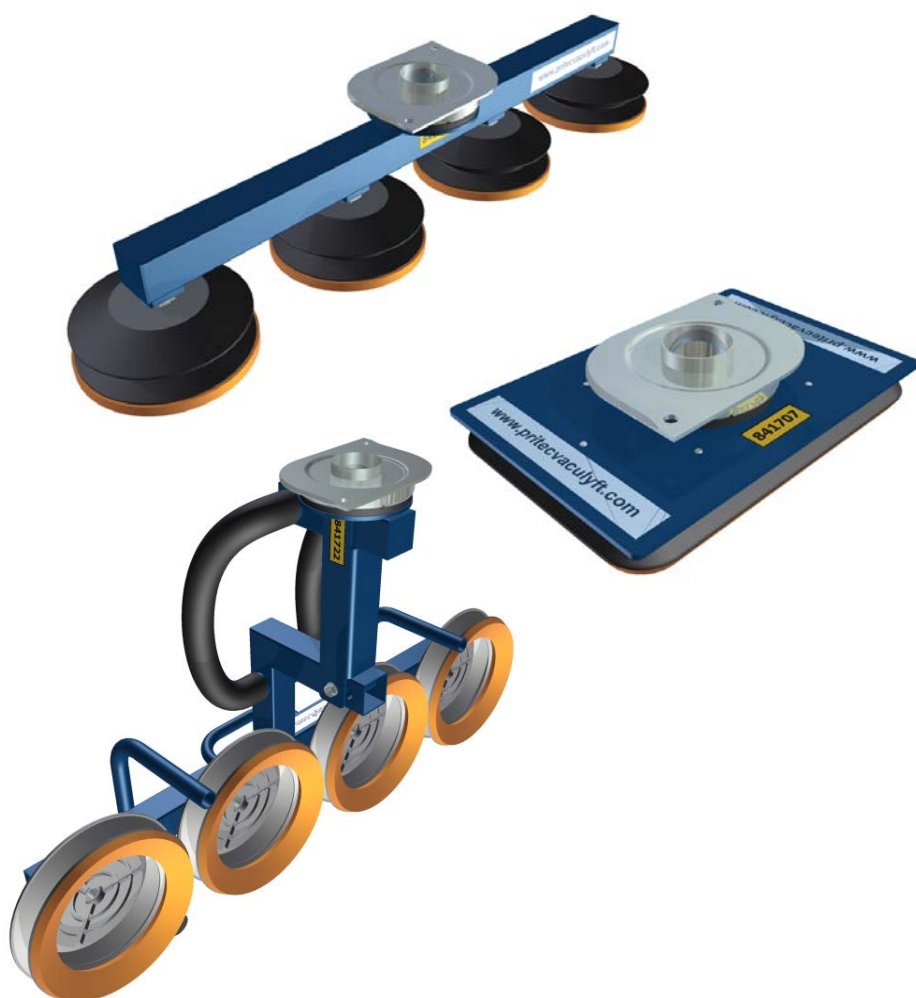

Pritec Vaculyft AB
Fjärås Industriväg 9
439 74 FJÄRÅS
Sweden

Tel: +46 300- 543 543
Email: info@pritecvaculyft.com
www.pritecvaculyft.com



841701

Used to:
Slabs 21x21cm 4pc, Kerbs, Block, Wallstone etc.
Up to 140kg

Lift tube Ø (mm)	140	160	180	200	250
	X	X	X		

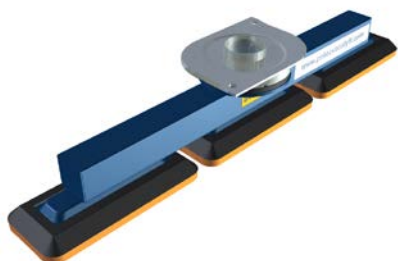

841702

Used to:
Slabs 21x21cm 3pc, Kerbs Blockstone etc.
Up to 80kg

Lift tube Ø (mm)	140	160	180	200	250
	X	X			

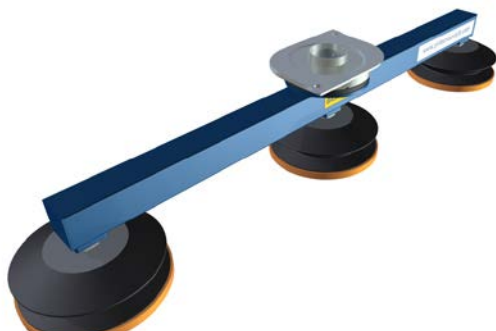

841703

Used to:
Slabs 35x35cm 3pc, Kerbstone etc.
Up to 80kg

Lift tube Ø (mm)	140	160	180	200	250
	X	X			



841704

Used to:
Slabs 35x35cm 4pc, Kerbstone etc.
Up to 100kg

Lift tube Ø (mm)	140	160	180	200	250
	X	X	X		

841705



Used to:
Kerbstone 92x8,5cm.
Up to 120kg

Lift tube Ø (mm)	140	160	180	200	250
	X	X	X		

841706

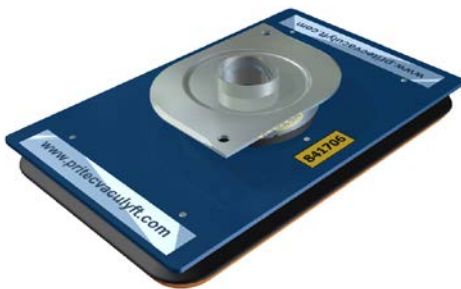

Used to:
Slabs 35x35cm and up, Block, Wallstone etc.
Up to 140kg

Lift tube Ø (mm)	140	160	180	200	250
	X	X	X	X	

841707

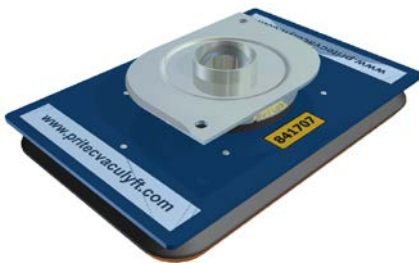

Used to:
Slabs 30x30cm and up, Block, Wallstone etc.
Up to 100kg

Lift tube Ø (mm)	140	160	180	200	250
	X	X			

841708

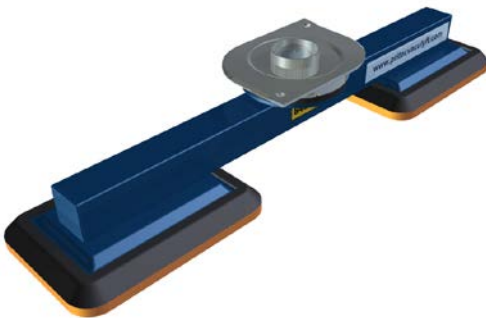

Used to:
Slabs 35x35cm 2pc, 40x40cm 3pc, 45x45cm 2pc
Up to 80kg

Lift tube Ø (mm)	140	160	180	200	250
	X	X	X		

841709

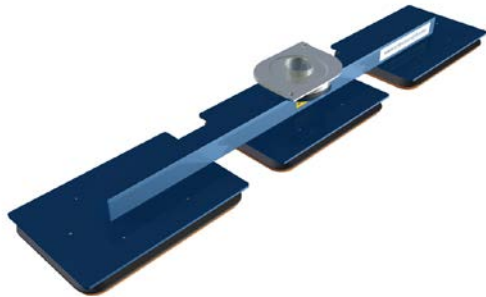

Used to:
Slabs 35x35cm 3pc
Up to 140kg

Lift tube Ø (mm)	140	160	180	200	250
	X	X	X	X	X

841711

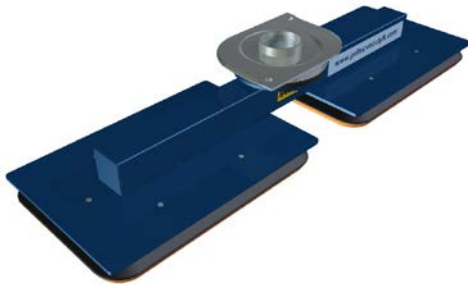

Used to:
Slabs 35x35cm to 60x60cm 2pc Block Wallstone
etc.
Up to 140kg

Lift tube Ø (mm)	140	160	180	200	250
	X	X	X	X	X

841716



Used to:
Kerbstone angled 45°
Up to 140kg

Lift tube Ø (mm)	140	160	180	200	250
	X	X	X	X	

841718

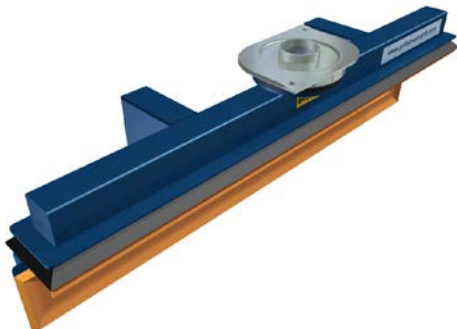

Used to:
Kerbstone
Up to 140kg

Lift tube Ø (mm)	140	160	180	200	250
	X	X	X	X	X



841719

Used to:
Slabs 17x17cm 5pc
Up to 140kg

Lift tube Ø (mm)	140	160	180	200	250
	X	X	X	X	

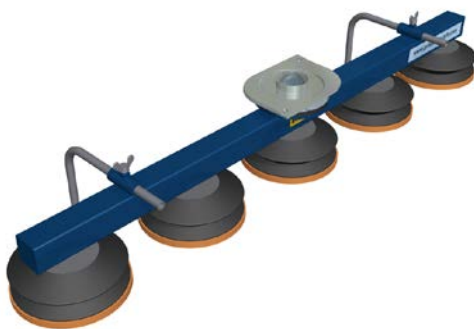

841720

Used to:
Multi: 21x21cm 5pc, 30x30cm 4pc
Up to 120kg

Lift tube Ø (mm)	140	160	180	200	250
	X	X	X		



841721

Used to:
Slabs 35x35cm 3pc
Up to 140kg

Lift tube Ø (mm)	140	160	180	200	250
	X	X	X	X	



841722

Used to:
Granit Kerbstone tilt function.
Up to 140kg

Lift tube Ø (mm)	140	160	180	200	250
	X	X	X	X	

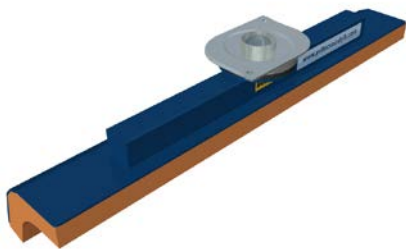

841723

Used to:
Kerbstone typ Spikma
Up to 140kg

Lift tube Ø (mm)	140	160	180	200	250
	X	X	X	X	

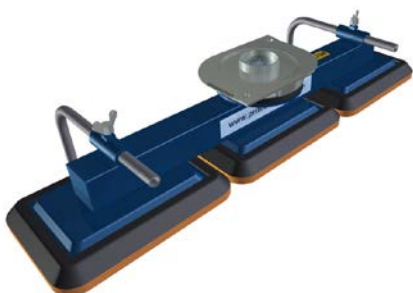

841724

Used to:
Block 21x21cm 3pc etc.
Up to 100kg

Lift tube Ø (mm)	140	160	180	200	250
	X	X	X		



841725

Used to:
Circus St Erics
Up to 140kg

Lift tube Ø (mm)	140	160	180	200	250
	X	X	X	X	



841726

Used to:
Superförband 2 rows
Up to 140kg

Lift tube Ø (mm)	140	160	180	200	250
	X	X	X		

841727

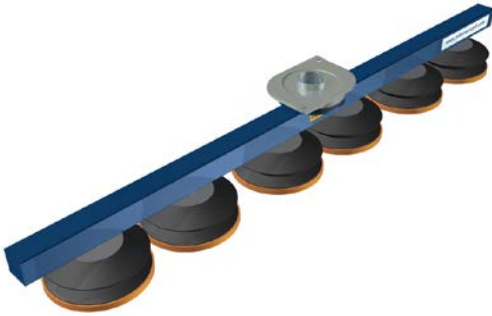

Used to:

Multi: 21x21cm 6ps, 21x21cm 5pc, 35x35cm 3pc

Up to 140kg

Option: 30x30cm 4pc

Lift tube Ø (mm)	140	160	180	200	250
	X	X	X	X	

641009

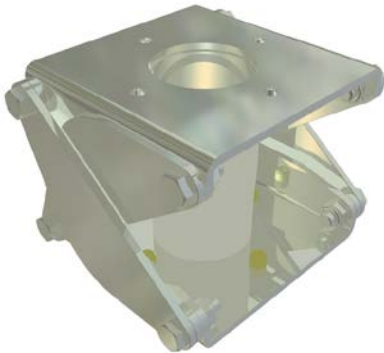

Angle adapter 0-90°, For vertical handling

841728

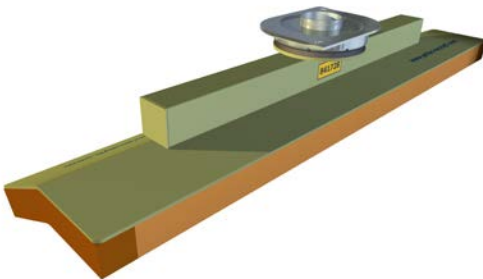

Used to:

Kerbstone type Trottoirband

Up to 140kg

Lift tube Ø (mm)	140	160	180	200	250
	X	X	X	X	

841731

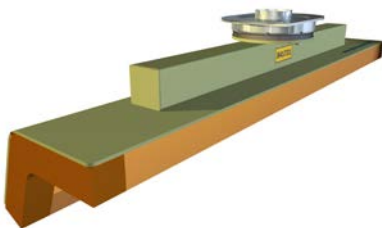

Used to:

Kerbstone Norway

Up to 120kg

Lift tube Ø (mm)	140	160	180	200	250
	X	X	X	x	

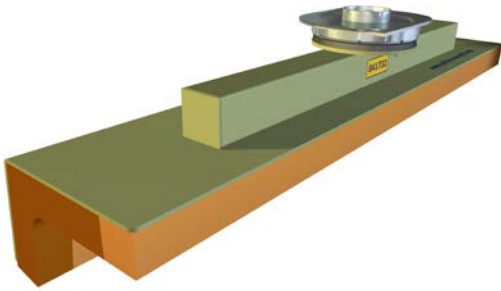

841732

Used to:
Kerbstone Netherlands
Up to 140kg

Lift tube Ø (mm)	140	160	180	200	250
	X	X	X	X	

841733

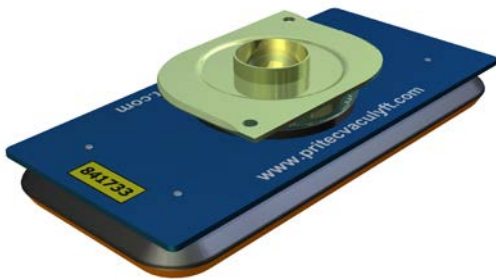

Used to:
Slabs wall 15x33cm
Up to 80kg

Lift tube Ø (mm)	140	160	180	200	250
	X	X			

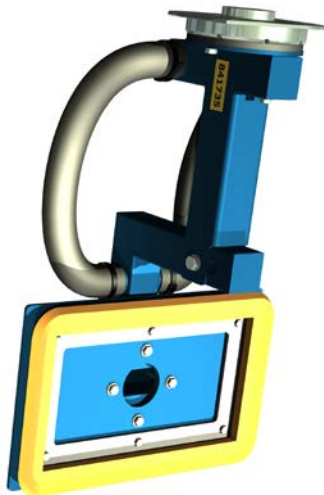

841735

Used to:
Kerb, wall stone side lift. 21x33cm
Up to 120kg

Lift tube Ø (mm)	140	160	180	200	250
	X	X	X		

841736

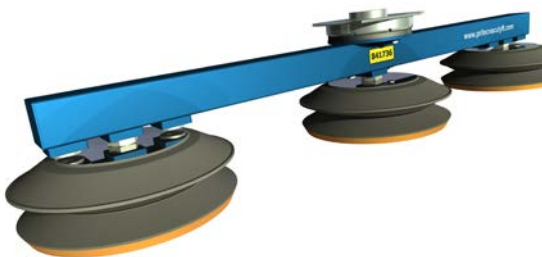

Used to:
Multi: Slabs 3x Ø200 30+35+40cm/cc
Up to 140kg

Lift tube Ø (mm)	140	160	180	200	250
	X	X	X	X	



841737

Used to:
Kerstone radius adjustable Ø200x4
Up to 140kg

Lift tube Ø (mm)	140	160	180	200	250
	X	X	X	X	



841738

Used to:
Slabs side shift 21x14cm
Up to 140kg

Lift tube Ø (mm)	140	160	180	200	250
	X	X	X	X	



841739

Used to:
Slabs side shift 20x20cm
Up to 140kg

Lift tube Ø (mm)	140	160	180	200	250
	X	X	X	X	

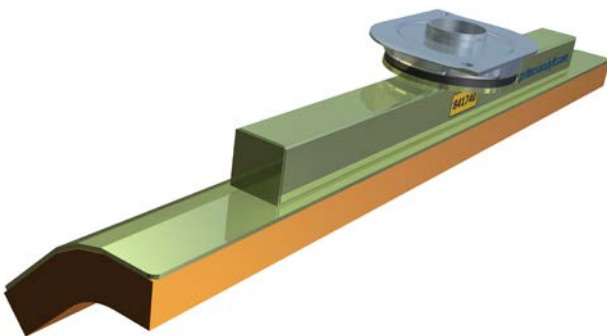

841740

Used to:
Kerbstone Spikma A100
Up to 140kg

Lift tube Ø (mm)	140	160	180	200	250
	X	X	X	X	



841742

Used to:
Slabs side shift 20x13cm
Up to 140kg

Lift tube Ø (mm)	140	160	180	200	250
	X	X	X	X	

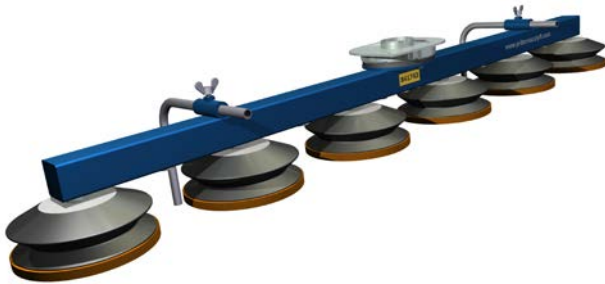

841743

Used to:
Slabs 1 row (5 or 6 pcs) 21x21cm
Up to 140kg

Lift tube Ø (mm)	140	160	180	200	250
	X	X	X	X	

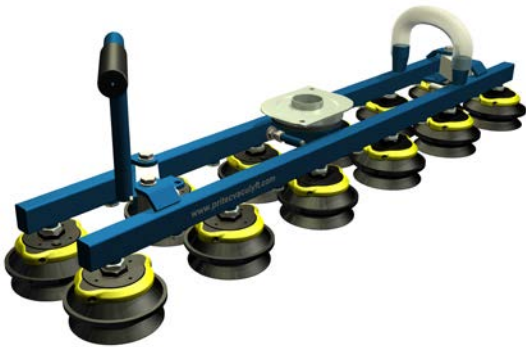

841744

Used to:
Slabs side shift 19,5x13cm
Up to 140kg

Lift tube Ø (mm)	140	160	180	200	250
	X	X	X	X	



841745

Used to:
Slabs side shift Kartano
Up to 140kg

Lift tube Ø (mm)	140	160	180	200	250
	X	X	X	X	



841746

Used to:
Slabs side shift 40x20cm(6pcs) and 20x20cm
(12pcs)
Up to140kg

Lift tube Ø (mm)	140	160	180	200	250
	X	X	X	X	



841747

Used to:
Slabs Windermere
Up to140kg

Lift tube Ø (mm)	140	160	180	200	250
	X	X	X	X	



841750-024

Used to:
Scissors tool grass reinforcement and wall stone
Up to140kg

Lift tube Ø (mm)	140	160	180	200	250
	X	X	X	X	X